



fan data

21.10.2024

version FANselect V 1.01 (241021), AMCA V 1.03 September, 2021
RLT V 1.00 Dezember, 2021 / 1.24.10.21 | 30813 | (user ZAFS20813)



type	FN071-SDA.6F.V7P1	
article no.	141768 Portfolio STD-WWW	
note	-	design "A" - please check for additional components

technical data

motor		AC
mains supply	-	3~ 400V 50Hz D
nominal current (I_N)	A	1.70
ambient temperature, max. limit (t_a)	°C	70
efficiency grade η_{statA}	%	39,1
efficiency grade N_{actual} N_{target}		45,8 40
ErP-conformity		2015
grille influence		without

fan data

frequency (f_{DP}) (f_{max})	Hz	50 50
dimensions (w x h x d)	mm	703 x 703 x 226
product weight (m_{pr})	kg	17.2

PF:PF_50; Type:FN071-SDA; STol:+-10 %

FANselect



performance curve / acoustics

21.10.2024

Version FANselect V 1.01 (241021), AMCA V 1.03 September, 2021
RLT V 1.00 Dezember, 2021 / 1.24.10.21 | 30813 | (user ZAFS20813)

1 FN071-SDA.6F.V7P1

Measured in full nozzle without guard grille in air flow direction V in installation type A according to ISO5801

141768 | Portfolio STD-WW measurement density 1.18 [kg/m³]

air performance p_{sF}

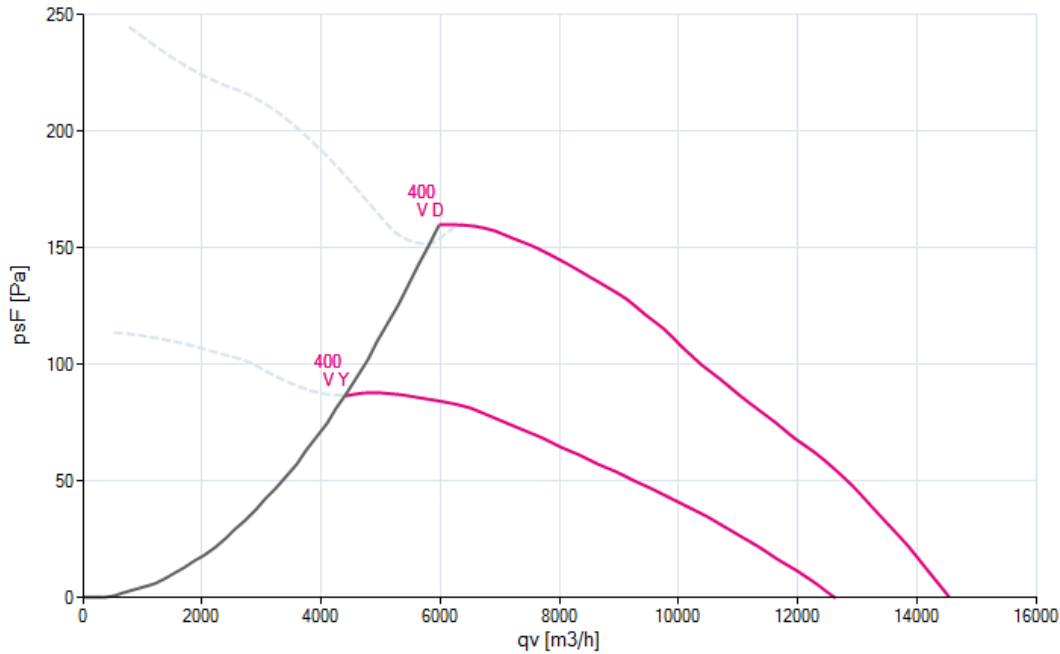

acoustics ($L_{w(A),5}$)

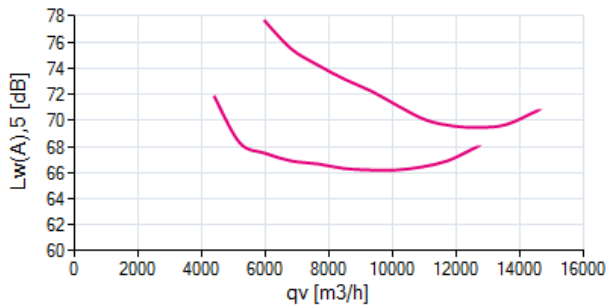

acoustics ($L_{w(A),6}$)

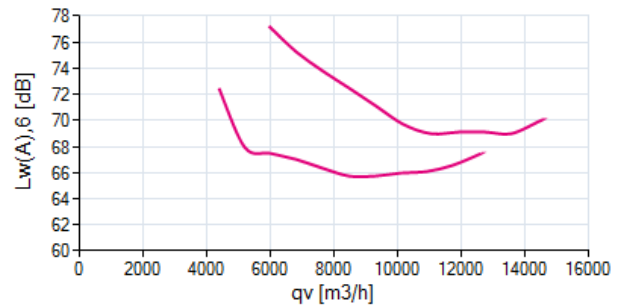

1 FN071-SDA.6F.V7P1

f [Hz]	sum	63	125	250	500	1000	2000	4000	8000
$L_{w(A),5}$	-	-	-	-	-	-	-	-	-
$L_{w,5}$	-	-	-	-	-	-	-	-	-

f [Hz]	sum	63	125	250	500	1000	2000	4000	8000
$L_{w(A),6}$	-	-	-	-	-	-	-	-	-
$L_{w,6}$	-	-	-	-	-	-	-	-	-

FANselect



efficiency grade / power input

21.10.2024

Version FANselect V 1.01 (241021), AMCA V 1.03 September, 2021
RLT V 1.00 Dezember, 2021 / 1.24.10.21 | 30813 | (user ZAFS20813)

1

FN071-SDA.6F.V7P1

Measured in full nozzle without guard grille in air flow direction V in installation type A according to ISO5801

141768 | Portfolio STD-WW

measurement density 1.18 [kg/m³]

efficiency grade η_F

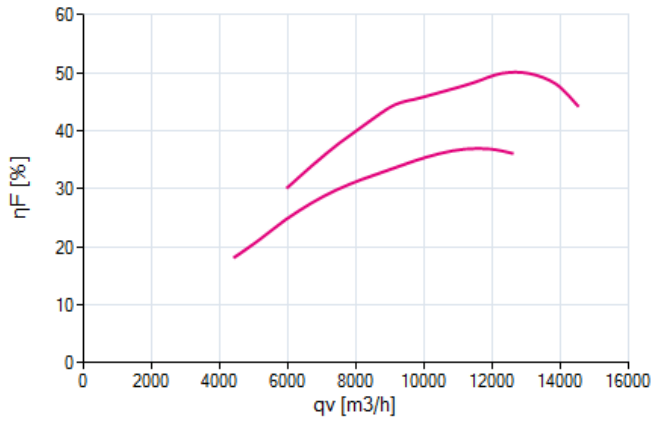

efficiency grade η_{sF}

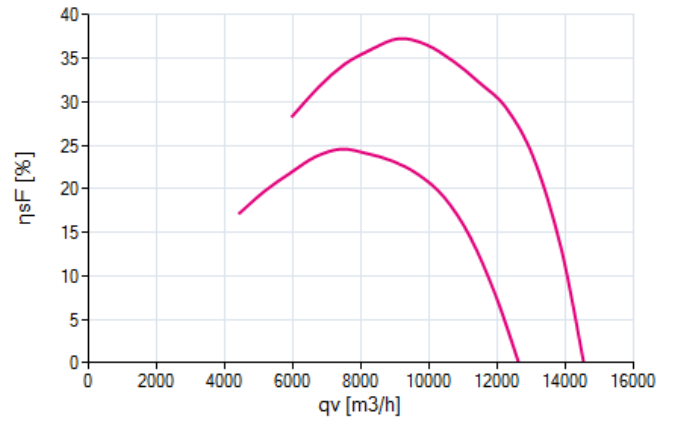

power input P_1

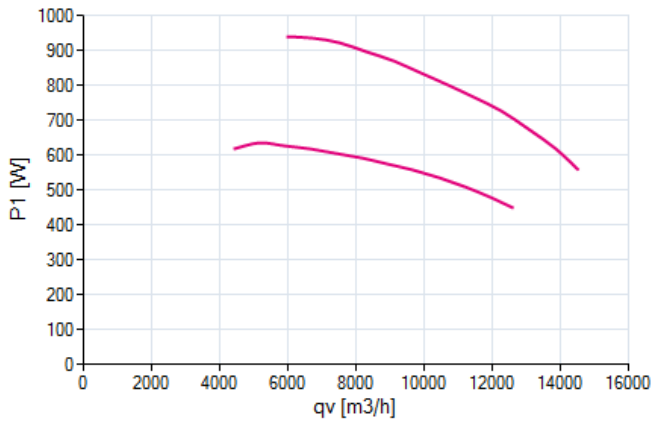



nominal values

21.10.2024

version FANselect V 1.01 (241021), AMCA V 1.03 September, 2021
RLT V 1.00 Dezember, 2021 / 1.24.10.21 | 30813 | (user ZAFS20813)

1



FN071-SDA.6F.V7P1

141768

3~ 400V +10/-10 D/Y 50Hz P1 0.94/0.62kW P2 0.72/0.31kW
 1.70/1.05A DI=10% 900/690/MIN COSY 0.79 70°C
 IP54 THCL155

drawing

21.10.2024

version FANselect V 1.01 (241021), AMCA V 1.03 September, 2021
RLT V 1.00 Dezember, 2021 / 1.24.10.21 | 30813 | (user ZAFS20813)

1



FN071-SDA.6F.V7P1

141768

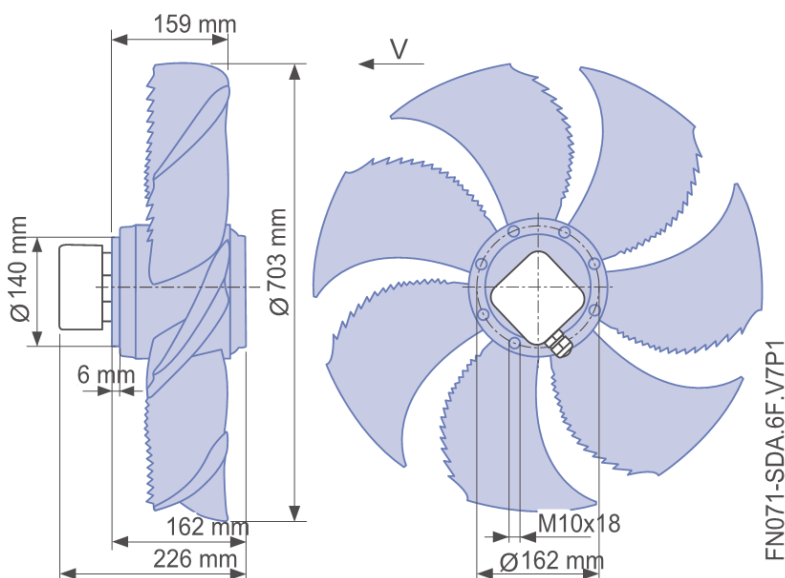

wiring diagram

21.10.2024

version FANselect V 1.01 (241021), AMCA V 1.03 September, 2021
RLT V 1.00 Dezember, 2021 / 1.24.10.21 | 30813 | (user ZAFS20813)

1



FN071-SDA.6F.V7P1

141768

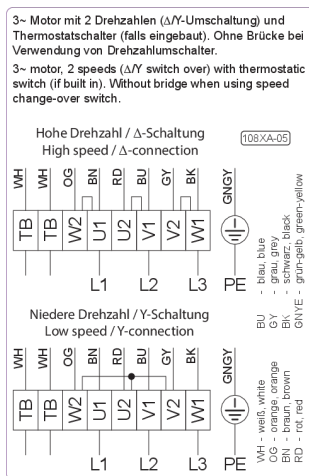

FANselect



system components

21.10.2024

Version FANselect V 1.01 (241021), AMCA V 1.03 September, 2021
RLT V 1.00 Dezember, 2021 / 1.24.10.21 | 30813 | (user ZAFS20813)



type	FN071-SDA.6F.V7P1
article no.	141768